

# ABUTMENT FLASHINGS STEEL SHEETING



Achieve a clean, weather-resistant finish where your roof meets a wall or internal angle with Cladco 3m polyester paint abutment flashings. Manufactured from galvanised steel and folded to a 110° internal angle with 10-15° flex, each piece includes a 5mm safety welt and provides a durable, smooth-coated finish. Compatible with 13/3 corrugated, 32/1000 and 34/1000 box profile sheets.

## AVAILABLE COATINGS

-  POLYESTER PAINT
-  PVC PLASTISOL
-  GREENCOAT® PURAL
-  GALVANISED

## FLASHING SPECIFICATIONS

Length	3m
Available Thickness	0.7mm
Angle	110° Internal Angle
Sizes	200mm x 200mm
Coverage	195mm x 195mm
Colours	20 Across 3 Finishes

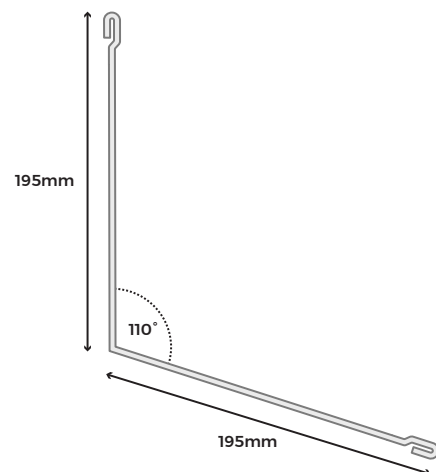

*Illustration shown - welt detail may differ from the item supplied.*

**Please note:** Images are for illustration purposes only. Actual products may vary slightly from those shown.



Colours To Match Your Metal Sheeting



Can Be Made-To-Measure



Creates A Neat Weather Resistant Junction



Safety Welt Increases Rigidity



### MATERIALS

Manufactured from high-tensile, cold-rolled steel, coated for superior corrosion resistance and long-lasting protection. The coatings are oven-cured to ensure durability, providing resistance to abrasion and weathering.



### SURFACES

Choose from PVC plastisol, polyester paint, GreenCoat® Pural BT, or galvanised finishes - each offering different levels of durability, protection, and visual appeal to suit your project.



### ACCESSORIES

A full range of flashings, purlins, and fixings are available to match your sheets, ensuring a watertight, durable, and visually consistent finish.



### LOW MAINTENANCE

Durable coated finishes require minimal upkeep, resisting weathering, dirt build-up, and corrosion for a long-lasting, low maintenance exterior solution.



### LONGEVITY

PVC Plastisol: 15-25 years.  
Polyester Paint: 8-12 years.  
GreenCoat® Pural BT: Up to 40 years.  
Galvanised: Up to 12 years.

Lifespan varies depending on installation environment and ongoing maintenance.



[www.cladco.co.uk](http://www.cladco.co.uk)

T: 01837 659901 E: [info@cladco.co.uk](mailto:info@cladco.co.uk)

**CLADCO**  
PROFILES®

## ABUTMENT FLASHING SKU

### Coating and Colour

Polyester Paint Coated, Juniper Green	AFBJG
Polyester Paint Coated, Light Grey	AFBLG
Polyester Paint Coated, Black	AFBBL
Polyester Paint Coated, White	AFBWH
Polyester Paint Coated, Slate Blue	AFBSB
PVC Plastisol Coated, Juniper Green	AFAJG
PVC Plastisol Coated, Goosewing Grey	AFAGG
PVC Plastisol Coated, Black	AFABL
PVC Plastisol Coated, Anthracite	AFAAN
PVC Plastisol Coated, Chestnut	AFACH
PVC Plastisol Coated, Slate Blue	AFASB
PVC Plastisol Coated, Vandyke Brown	AFABR
PVC Plastisol Coated, Merlin Grey	AFAMG
PVC Plastisol Coated, Moorland Green	AFAMO
PVC Plastisol Coated, Olive Green	AFAOG
PVC Plastisol Coated, White	AFAWH
GreenCoat® Pural BT, Nordic Night Black	AFMMB
GreenCoat® Pural BT, Silver Fir Green	AFMFG
GreenCoat® Pural BT, Slate Grey	AFMSL
GreenCoat® Pural BT, Tile Red	AFMTR
Galvanised	AFG

## MADE IN BRITAIN

Cladco is a proud member of Made in Britain—the official collective mark for UK manufacturers who meet strict criteria for domestic production.

As part of this trusted network, we are licensed to use the Made in Britain trademark across our materials, highlighting our ongoing commitment to UK-based manufacturing, quality, and traceability.

This mark is more than just a symbol—it represents a national movement to support sustainable British industry, protect consumers, and champion local businesses. Only verified members can display the registered trademark, offering confidence that our products bearing the mark are genuinely made in Great Britain or Northern Ireland.



### CUSTOMER BENEFITS OF BUYING FROM A MADE IN BRITAIN MEMBER

#### Trusted Quality, Recognised Nationwide

We're licensed to use the official Made in Britain trademark—giving you confidence that our products meet strict UK manufacturing standards and quality benchmarks. When you see the mark, you know you're buying trusted, UK-made goods.

#### Supporting British Industry & Local Jobs

By choosing Cladco, you're supporting ethical manufacturing, UK-based jobs, and transparent, traceable supply chains. These values matter—not just to us, but to customers who care about where and how their products are made.

#### Easier to Find, Easier to Trust

We're listed in the official Made in Britain Member Directory with live contact info, location pin, and verified branding—making it easier for customers and trade partners to connect with a trusted UK supplier.

#### Products Built to Last

The Made in Britain mark is your reassurance that our products are built with care, comply with UK regulations, and are made to perform. It's a symbol of quality and durability you can rely on.

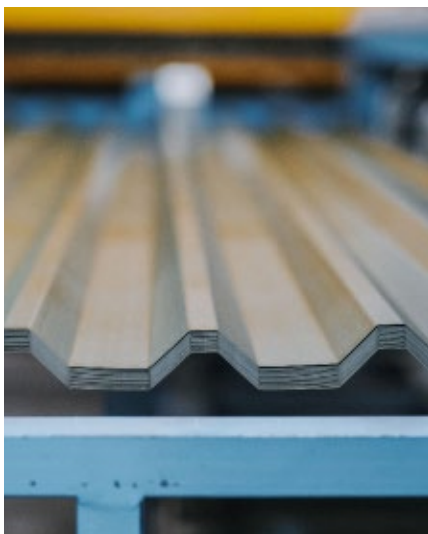

[www.cladco.co.uk](http://www.cladco.co.uk)

T: 01837 659901 E: [info@cladco.co.uk](mailto:info@cladco.co.uk)

# PVC PLASTISOL COATING - BUILT FOR PERFORMANCE

Our PVC plastisol-coated sheets are manufactured using a multi-layer system applied to zinc-coated, high-tensile steel and oven-cured for superior adhesion.

This process creates a tough, corrosion-resistant surface with excellent protection against the elements and strong resistance to wear and damage.

Available in a wide range of colours, plastisol coatings offer a practical, long-lasting solution that balances visual appeal with dependable performance.



## PVC PLASTISOL CHART



### QUALITY

Plastisol is applied to a hot-dipped 55% Aluzinc-coated steel substrate, offering excellent corrosion resistance and up to six times the durability of standard galvanised steel.



### UV RESISTANCE

The plastisol coating is made from polyvinyl chloride-based thermoplastic resins with short molecular chains, offering enhanced UV resistance, making it particularly well-suited to construction and external applications.



### HEAT RESISTANCE

Performs between -40°C and +80°C. The coating withstands expansion and contraction without compromising its finish.



### DURABILITY

Embossed 200-micron coating offers excellent scratch resistance, ideal for demanding environments. The leather-grain texture helps hide minor scuffs, making it highly durable during handling and installation.



### LONGEVITY

PVC plastisol-coated metal sheets typically provide 15-25 years of protection before requiring maintenance or repainting, with a total lifespan of over 30 years in standard environments.



[www.cladco.co.uk](http://www.cladco.co.uk)

T: 01837 659901 E: [info@cladco.co.uk](mailto:info@cladco.co.uk)

**CLADCO**  
PROFILES®

# PVC PLASTISOL PERFORMANCE OVERVIEW

## POSCO C&C Plastisol - Long-Lasting Protection

POSCO C&C's plastisol coating offers superior performance compared to standard pre-painted finishes. With enhanced durability, excellent corrosion resistance, and advanced colour retention, it delivers long-term reliability in even the most demanding environments. Backed by a performance warranty of up to 30 years, it's a trusted choice for high-performance metal roofing and cladding applications.

- Key Features of POSCO C&C Plastisol-Coated Sheets
- 200µm abrasion-resistant topcoat for exceptional durability
- Leathergrain embossed finish for a refined, textured appearance
- Wide range of colours to suit various design requirements
- Aluzinc substrate for outstanding corrosion resistance
- 57µm reverse primer coat suitable for foam adhesion
- Excellent formability for complex profiles and shapes
- High colour stability for long-lasting visual appeal
- Suitable for low-pitch roofs – down to 1°
- Fire certified for added safety assurance

### PVC Plastisol Coating Layers

TOPCOAT
PRIMER
PRE-TREATMENT
BASE METAL (STEEL)

	Test Results	Test Standards
<b>Film Thickness</b>	Ave. 200µm	EN 13523-1
<b>Gloss (60°)</b>	10-35%	EN 13523-2
<b>Emboss</b>	Leathergrain	
<b>Abrasion resistance (CS-10, 1kg, 250rev)</b>	10-15mg	EN 13523-16
<b>Scatch resistance</b>	> 5000g	EN 13523-12
<b>Flexibility</b>	T-Bend (OT, 16°C)	EN 13523-7
<b>Reverse impact</b>	18J	EN 13523-5
<b>Salt Spray Resistance</b>	1000 hours	EN 13523-8
<b>Humidity Resistance</b>	1500 hours	EN 13523-26
<b>Internal Environment Classification</b>	CPI5	EN 10169
<b>Corrosion Resistance Category</b>	RD5	EN 10169
<b>UV Resistance Category</b>	Ruv3	EN 10169
<b>Fire Classification</b>	C - s2, d0	EN 13051-1
<b>Guarantee</b>	Up to 30 years	

## ALUZINC SUBSTRATE

- Plastisol is applied to a hot-dipped steel sheet coated with a 55% aluminium-zinc (aluzinc) alloy. This combination delivers exceptional long-term performance in harsh environments:
- Provides both the strong oxidisation resistance of aluminium and the sacrificial cathodic protection of zinc
- Offers 3 to 6 times the durability of standard galvanised steel in corrosive conditions
- Maintains excellent formability and structural integrity, even at bend points, due to minimal micro-cracking during forming

## PVC PLASTISOL COATING (POSCO C&C)

- POSCO C&C's Plastisol Coating combines the protective benefits of thermoplastic resins with outstanding flexibility and weather resistance:
- The coating can elongate up to 300-400% without cracking, making it ideal for heavy forming and processing
- Formulated with short-chain polyvinyl chloride-based resins for enhanced UV stability and colour retention
- Multi-layer system applied to Aluzinc-coated high-tensile steel and oven-cured for maximum adhesion and strength
- Delivers superior corrosion resistance, chemical protection, abrasion resistance, and climatic durability

## POLYESTER PAINT COATED – VERSATILE & COST-EFFECTIVE

Our 25-micron polyester paint finish offers a smooth, economical solution with reliable weather resistance and moderate scratch protection.

In standard environments, maintenance is typically required after 8-12 years, with an overall lifespan of 20+ years.

Available in a wide range of colours, this coating delivers a balance of performance and visual appeal. Polyester-coated sheets are supplied in corrugated, box profile, and flat sheet formats, and feature a light grey reverse coating for added protection during installation and use.

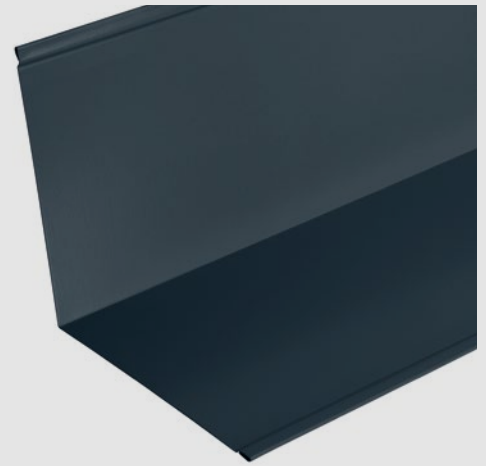

### POLYESTER PAINT COATING CHART



#### QUALITY

This finish features a fine, smooth polyester coating, offering excellent weather resistance at an economical price point. Applied to quality galvanised steel, it provides a clean, uniform appearance and reliable performance.



#### UV RESISTANCE

Offers reliable UV protection for general outdoor applications, with colours remaining stable for several years. In typical UK conditions, the finish performs well, making it a practical choice in areas with moderate sun exposure.



#### HEAT RESISTANCE

Thermally stable from -40°C to +80°C, this coating resists blistering, peeling, and degradation in both high and low temperature conditions—ensuring reliable performance year-round.



#### DURABILITY

The 25-micron smooth polyester coating offers moderate scratch resistance and should be handled with care to prevent scuffs or surface marks—especially during transport and installation.

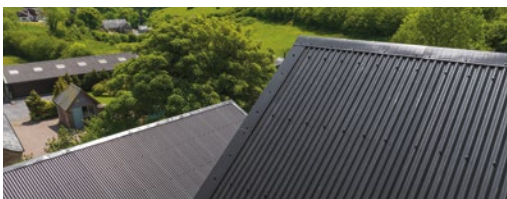

#### LONGEVITY

Provides 8-12 years of protection before maintenance is required, with an expected lifespan of 20+ years in standard UK environments.

## GALVANISED – COST-EFFECTIVE PROTECTION WITH A CLASSIC FINISH

Cladco's galvanised roof sheets feature a protective zinc coating, offering a durable, low-maintenance, and economical solution for a wide range of applications.

With their traditional metallic appearance, galvanised finishes are ideal for agricultural and industrial projects where a coloured coating isn't required.

Available in box profile, corrugated, and flat sheet options, these sheets are suitable for use in roofing, flashings, weatherproofing, and internal lining of floors or walls.



### GALVANISED COATING CHART

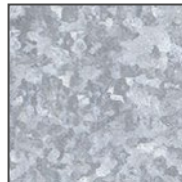

Galvanised



#### QUALITY

Manufactured from hot-dip galvanised steel with a 275g/m<sup>2</sup> zinc coating, this finish offers a durable, cost-effective, and low-maintenance solution with a classic metallic appearance.



#### UV RESISTANCE

Galvanised steel is inherently UV stable. While the bright metallic finish will naturally weather to a muted grey patina over time, it will not fade, peel, or deteriorate under sunlight—offering long-term reliability without the need for additional coatings.



#### HEAT RESISTANCE

Galvanised steel offers excellent thermal resilience. With no painted topcoat, there's nothing to degrade, blister, or peel—ensuring consistent performance in both high and low temperature conditions.



#### DURABILITY

The uncoated zinc finish provides moderate scratch resistance. While exposed areas are more susceptible to abrasion, minor scratches can self-heal over time through natural zinc oxidation, helping maintain protection in everyday use.



#### LONGEVITY

Galvanised sheets typically last up to 20 years, though they may require earlier maintenance than coated alternatives—particularly in harsh or coastal environments.

To prevent white rust, sheets should be stored in a dry, well-ventilated area. Prolonged exposure to trapped moisture can result in a milky or chalky surface appearance, affecting aesthetics but not structural performance.



[www.cladco.co.uk](http://www.cladco.co.uk)

T: 01837 659901 E: [info@cladco.co.uk](mailto:info@cladco.co.uk)

**CLADCO**  
PROFILES®

## GREENCOAT® PURAL BT - CHOICE OF COATINGS

GreenCoat® Pural BT is a premium 0.7mm roofing finish offering outstanding resistance to UV, corrosion, and weathering. With excellent scratch resistance and formability—even down to -15°C—it supports year-round installation with ease.

This durable, bio-based coating is available in a range of attractive colours, including silver fir green and slate grey, allowing you to create a roof that complements its surroundings while delivering long-lasting performance.



### GREENCOAT® PURAL BT COATING CHART

			
Tile Red RAL8004	Nordic Night Black RAL9005	Silver Fir Green RAL6021	Slate Grey RAL7016



#### QUALITY

Is a premium Swedish steel finish using bio-based technology. Offers excellent durability, corrosion protection and a low-gloss, tile-like appearance.



#### UV RESISTANCE

Highly UV-resistant. Maintains colour and surface integrity with minimal fading or chalking.



#### HEAT RESISTANCE

Performs well in hot or cold climates. Coating remains stable under sustained temperature extremes.



#### DURABILITY

Pural BT offers high levels of durability with a robust matte finish. The bio-based coating resists mechanical wear and scratching better than standard polyester paint.



#### LONGEVITY

Low-maintenance coating with a service life exceeding 40 years. Often outlasts plastisol in long-term performance.



[www.cladco.co.uk](http://www.cladco.co.uk)

T: 01837 659901 E: [info@cladco.co.uk](mailto:info@cladco.co.uk)

**CLADCO**  
PROFILES®

## GREENCOAT® PURAL BT - TECHNICAL OVERVIEW

GreenCoat® Pural BT is a premium, bio-based coated steel designed for superior performance in roofing and cladding applications. Manufactured to EN 10169 standards and fully chromate-free, this coating uses Swedish rapeseed oil and other renewable raw materials to deliver exceptional sustainability alongside durability.

This high-performance steel provides RC5+ corrosion resistance, RUV5 UV protection (Matt), and a fire classification of A1 s1 d0, making it ideal for projects demanding long-term reliability. Its excellent scratch resistance (up to 40N) and ability to fold at temperatures down to -15°C ensures easier, year-round installation.

The newly developed Satin finish offers a contemporary look (gloss 20) while maintaining the same strength and weather resistance as the Matt, Metallic, and Regular ranges.



### KEY TECHNICAL PROPERTIES

Property	Matt	Metallic	Satin	Regular
Gloss Level	<5	40	20	40
Corrosion Resistance	RC5+	RC5+	RC5+	RC5+
UV Resistance	RUV5	RUV4	RUV4-5	RUV4
Fire Classification (EN13501-1)	A1 s1 d0	A1 s1 d0	A1 s1 d0	A1 s1 d0
Scratch Resistance	40N	35N	40N	40N
Lowest Forming Temperature	-15°C	-15°C	-15°C	-15°C
Coating Thickness	50µm	45µm	50µm	50µm
Steel Grades	S280GD, S320GD, S350GD, DX51D			
Zinc Coating	275 g/m <sup>2</sup>			
Available Widths	1000-1500mm (Metallic max 1420mm)			



#### Reverse Side Coating

Two-layer grey coating for improved corrosion protection and adhesion.



#### Protective Film

Optional film for installation protection; remove within six months of manufacture or one month post-installation.



#### Sustainability

Manufactured with bio-based technology, reducing environmental impact without compromising performance.

## STANDARD FLASHINGS

Flashings play a vital role in sealing corners, edges, joints, and other vulnerable areas, helping to prevent water ingress and enhance the finished look of your roof. From ridges to eaves, our steel flashings are available in a variety of styles, finishes, and colours to match your roofing sheets—delivering both protection and a professional appearance.

- Seals corners, edges, and junctions
- Helps prevent leaks and water damage
- Available in multiple colours to complement your sheets.

For bespoke solutions, see our Custom-Made Flashings range.

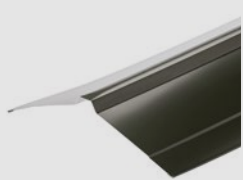
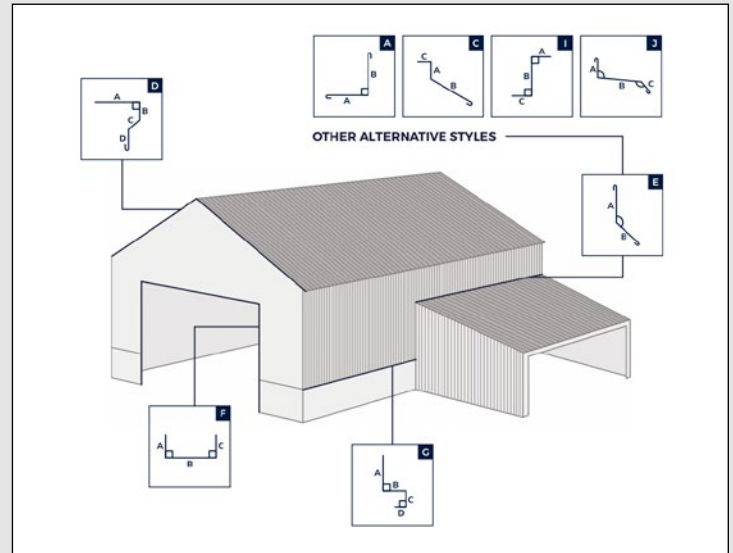

NORDIC RIDGE

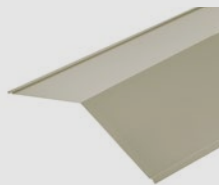

STANDARD RIDGE



DRIPTRAY FLASHING



BARGE FLASHING

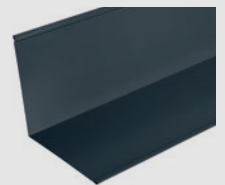

ABUTMENT FLASHING

## CUSTOM-MADE FLASHINGS

For non-standard roof designs or unique architectural details, custom flashings provide a precise, watertight finish tailored to your project.

Manufactured from durable 0.7mm flat sheet, Cladco's bespoke flashings are made to your exact specifications—up to 1200mm wide and 3m in length.

- Fabricated to your specified angles and sizes
- Available in a range of coatings and colours
- Simply provide dimensions using our lettered diagram
- A made-to-measure flashing ensures the best fit, protection, and finish—designed with your build in mind.

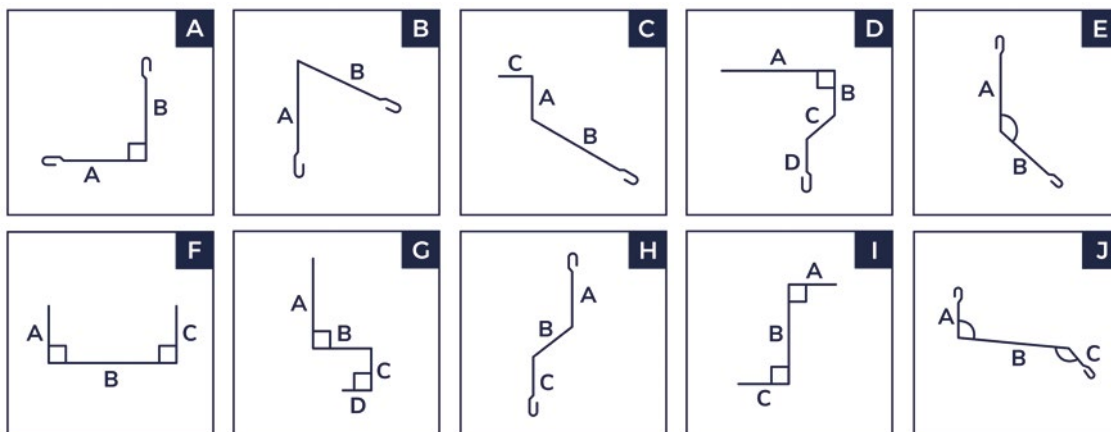

## INSTALLATION GUIDES

Correct installation is key to a long-lasting, weather-resistant finish. Our easy-to-follow guides walk you through each step—from sheet alignment and fixing methods to correct flashing placement.

Whether you're a first-time DIYer or a seasoned tradesperson, our Help & Advice section provides the confidence and clarity you need to complete your project properly.

Scan the QR codes below to access:

- [Roofing Sheet Installation Guide](#)
- [Flashings Installation Guide](#)
- [Roofing Help & Advice](#)



[FLASHING  
INSTALLATION  
GUIDE](#)



[CUSTOM  
FLASHINGS  
PAGE](#)

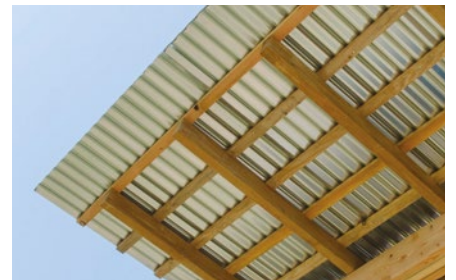

[ROOFING  
HELP AND  
ADVICE](#)

## PRODUCT ACCESSORIES



SAFETY  
GLOVES



MASTIC  
LAPPING TAPE



STITCHING  
SCREWS



COLOUR  
CAPS



CLADCO  
ADHESIVE  
SEALANT